

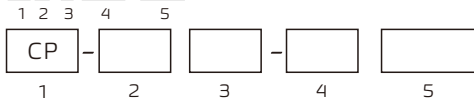

## Product Ordering Guide

### Sample

CP6-D15W-40E



### 1. Base Model

- CP

### 2. Aperture

- 4 4"
- 6 6"
- 8 8" (Only for round trim)
- 10 10" (Only for round trim)

### 3. Dimming

- D 1-10V Dimming

### 4. Wattage

- 10W
- 15W
- 20W
- 40W

### 5. CCT Adjustable

- 30E 3000K
- 35E 3500K
- 40E 4000K
- 50E 5000K
- 35T CCT Adjustable 3000K,3500K,4000K
- 40T CCT Adjustable 3000K,4000K,5000K

## Optional Ordering Guide

### Trim Shape

- Round Trim
- Square Trim
- Round Wall Wash Trim
- Square Wall Wash Trim

### Optional Mounting Kit

- 4" New Construction Frame Kit
- 6" New Construction Frame Kit
- 8" New Construction Frame Kit
- 10" New Construction Frame Kit

### Interactive Menu

Order Information.....	Page 1
Product Specification.....	Page 2
Dimension.....	Page 3-4
Photometric Data 6" 40W Round Trim.....	Page 5
Photometric Data 6" 40W Round Wall Wash.....	Page 6
Photometric Data 6" 40W Square Trim.....	Page 7
Photometric Data 6" 20W Square Wall Wash.....	Page 8

## Specification



Model No.	CPS-D10W-XXX	CPS-D15W-XXX	CPS-D20W-XXX	CPS-D20W-I35T	CPS-D40W-35T
Input Power	10W	15W	20W	20W	40W
Type	IC	IC	NON-IC	IC	NON IC
Trim Options	4",6",8",10"	4",6",8",10"	4",6",8",10"	4",6",8",10"	4",6",8",10"
Efficacy	75 LM/W	75 LM/W	75 LM/W	80 LM/W	80 LM/W
Luminous Flux	750 LM	1125 LM	1500LM	1600 LM	3200LM
1-10V Dimming	✓	✓	✓	✓	✓
120-347VAC Input	✓	✓	✓	✓	✓
110-277VAC Input Option*	✓	✓	✓	N/A	✓
CCT Adjustable Option	3000K, 4000K, 5000K	3000K, 4000K, 5000K	3000K, 4000K, 5000K	3000K, 3500K, 4000K	3000K, 3500K, 4000K
Wattage Adjustable Option	N/A	N/A	N/A	N/A	27W, 34W, 40W
Lifespan	35,000hrs	35,000hrs	35,000hrs	50,000hrs	50,000hrs
UL/CUL	✓	✓	✓	✓	✓
Energy Star	4",6",8"	4",6",8"	4",6",8"	4",6",8",10"	4",6",8",10"

\*110-277VAC version has not 1-10V dimming, CCT adjustable and wattage adjustable functions.

All efficacy is  $\pm 5\%$  base on different CCT and trim size. Check the IES file to gain the accurate data.

## Product Performance

## Structure

Spun aluminum reflector integrated with haze finish and white trim ring with shadow free.

## Trim Options

- Round Trim: 4", 6", 8", 10"
- Square Trim: 4", 6"
- Round Wall Wash Trim: 4", 6"
- Square Wall Wash Trim: 4", 6"

## Electrical

**LED Driver** It is powered by Class 2 high efficiency 120-347V LED driver, with a standard 1-10V driver which continuous dims to 10% that works with many types of controls. Tested Dimmers: Lutron® Diva-Dvtv, Leviton® IP-710-DL. Or optional 110-277VAC driver is non-dimmable.

**THD** <20%

**Power Factor** >0.9

**Input Voltage** Standard electronic drivers are cULus recognized and available for 110-277V or 120-347V AC.

## LED System

**CRI** Minimum 80 color rendering index

**CCT** 3000K, 3500K, 4000K and 5000K with a great color consistency

**Thermal Management** Aluminum housing acting as the heat sink to maximize life.

## Mounting

Durable tension clips are allowing for fast and easy flush installation

## Approvals

- cULus listed for damp locations
- Energy Star Listed
- Tested to IESNA LM-79 and LM-80

## Warranty

5-year limited warranty on LED and driver.

## Optional Function

**Emergency Option** Optional high power 100-277V emergency LED driver for lighting up to 120 minutes in event of power failure.



## Trim Dimensions

## Round Trims

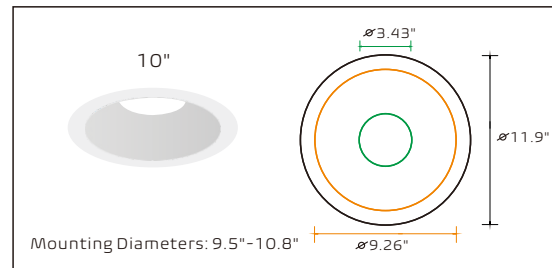
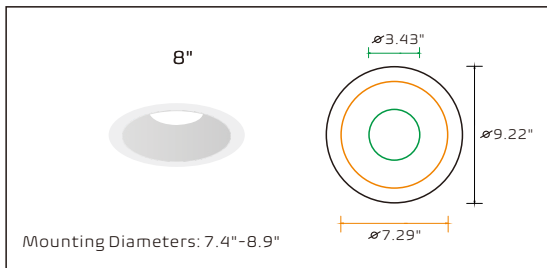
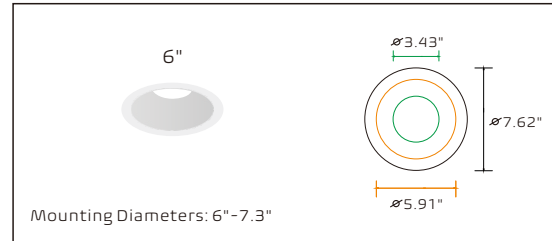
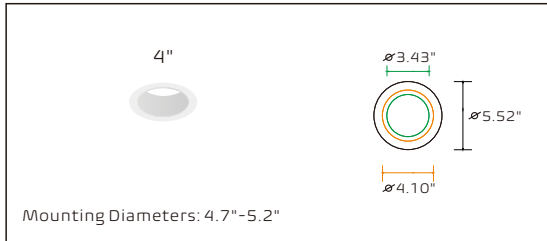

## Round Wall Wash Trims

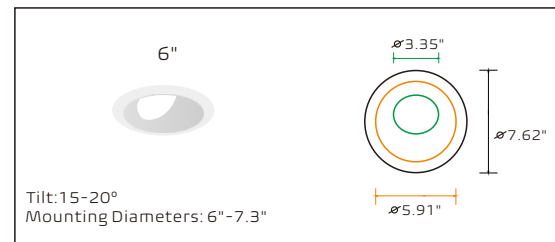

## Square Trims

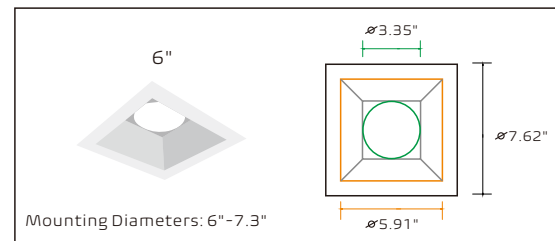
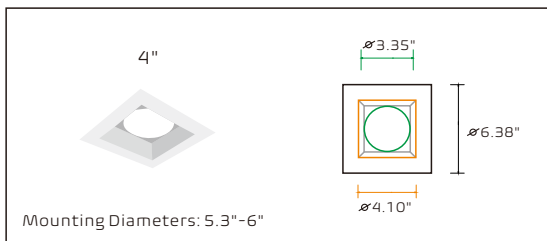

## Square Wall Wash Trims

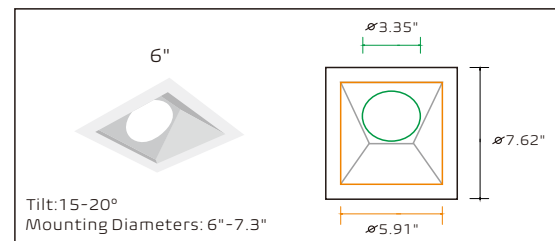
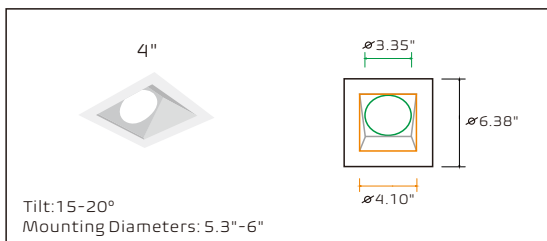

### Engine

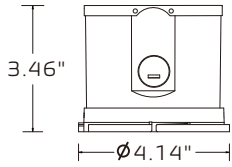

10W IC, 15W IC, 20W NON IC

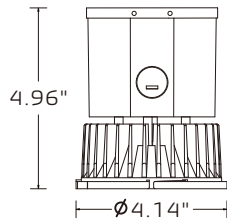

20W IC, 40W NON IC

### Optional New Construction Frame Kits

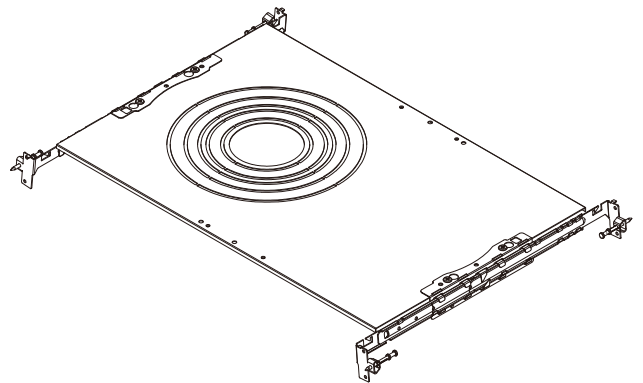
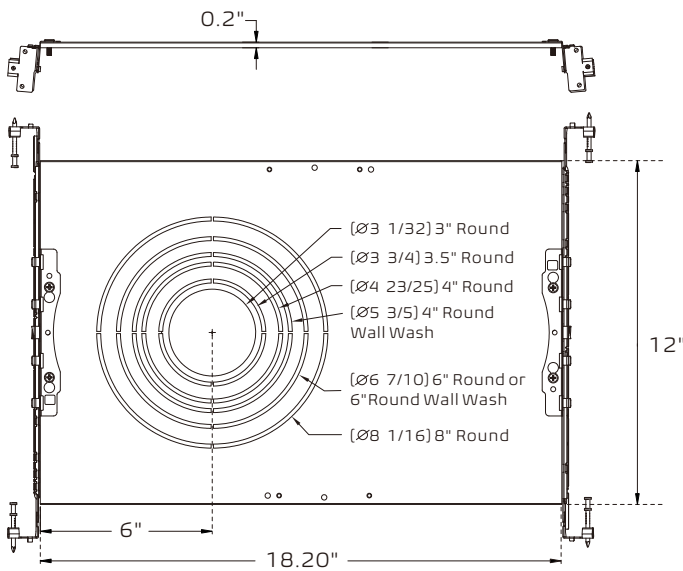

## Photometric for 6" 40w round trim

Fixture photometry has been conducted accredited testing laboratory in accordance with IESNA LM-79-08. IESNA LM-79-08 specifies the entire luminaire as the source resulting in a fixture efficiency of 100%. Result may vary per actual order.

### Distribution Diagram

CP6-D40W-40T-Round

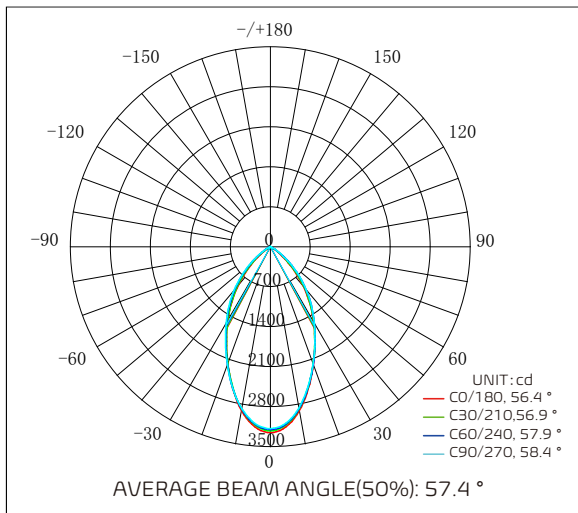

### Average Illuminance Curve

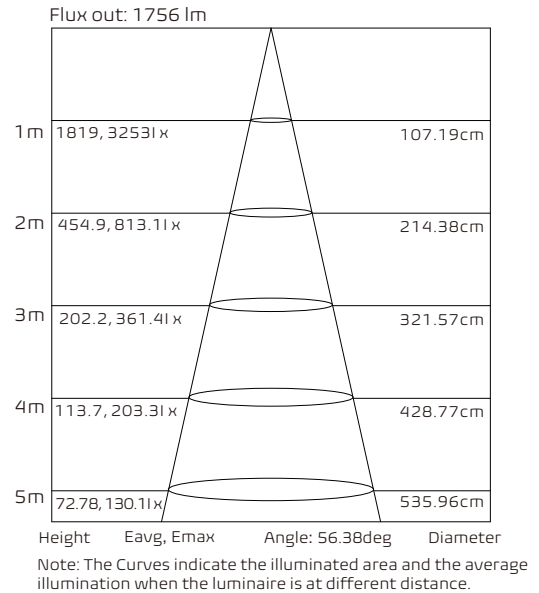

### Zonal Flux Diagram

T	C0	C45	C90	C135	C180	C225	C270	C315
10	2916	2896	2871	2857	2912	2879	2879	2847
20	2201	2209	2188	2161	2186	2173	2203	2164
30	1521	1544	1542	1506	1498	1511	1552	1516
40	891.0	956.2	972.7	929.2	869.3	928.2	987.2	941.9
50	335.4	424.5	441.2	395.6	321.0	402.9	451.4	401.2
60	58.83	91.82	97.54	78.63	54.01	80.69	104.7	80.35
70	3.285	2.050	1.504	1.915	3.235	2.035	1.621	2.036
80	1.606	0.8562	0.5011	0.8066	1.591	0.8574	0.4999	0.8304
90	0.1094	0.0676	0.0949	0.0811	0.0721	0.1087	0.0767	0.1179

DEG LUMINOUS INTENSITY:cd

### Zonal Lumen Summary

T	φ zone	φ total	%lum, lamp
0-10	289.3	289.3	8.69, 8.69
10-20	708.6	997.9	30, 30
20-30	842.1	1840	55.3, 55.3
30-40	760.8	2601	78.1, 78.1
40-50	500.0	3101	93.2, 93.2
50-60	188.9	3290	98.8, 98.8
60-70	27.06	3317	99.7, 99.7
70-80	1.566	3318	99.7, 99.7
80-90	0.6113	3319	99.7, 99.7

UNIT: lm

### Coefficients Of Utilization

ppc	80%			70%			50%			30%			10%			0		
pw	50%	30%	10%	50%	30%	10%	50%	30%	10%	50%	30%	10%	50%	30%	10%	0		
pfc	20%			20%			20%			20%			20%			0		
RCR	RCR:Room Cavlty Ratio						(CU)											
0.0	119	119	119	116	116	116	111	111	111	106	106	106	102	102	102	0		
1.0	110	107	104	107	105	103	103	101	0	0	98	97	96	95	94	92		
2.0	101	96	92	99	95	91	96	92	89	93	90	87	90	87	85	84		
3.0	93	87	83	91	86	82	88	84	81	86	82	79	84	81	78	76		
4.0	85	79	74	84	78	74	82	77	73	80	76	72	78	74	71	70		
5.0	79	72	67	78	72	67	76	71	67	74	70	66	73	69	65	64		
6.0	73	66	62	72	66	61	71	65	61	69	64	60	68	63	60	58		
7.0	68	61	57	67	61	56	66	60	56	65	60	56	63	59	55	54		
8.0	63	57	52	63	56	52	62	56	52	61	55	52	59	55	51	50		
9.0	59	53	48	59	53	48	58	52	48	57	52	48	56	51	48	46		
10.0	56	49	45	55	49	45	54	49	45	53	48	45	53	48	44	43		

## Photometric for 6" 40w round wall wash

Fixture photometry has been conducted accredited testing laboratory in accordance with IESNA LM-79-08. IESNA LM-79-08 specifies the entire luminaire as the source resulting in a fixture efficiency of 100%. Result may vary per actual order.

### Distribution Diagram

CP6-D40W-30W-Round Wall Wash

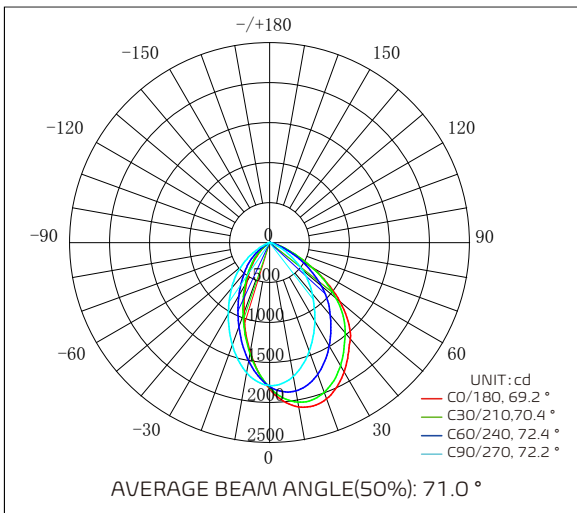

### Average Illuminance Curve

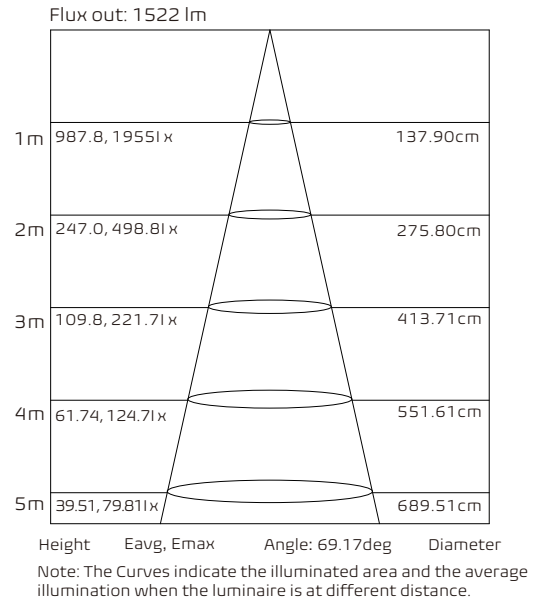

### Zonal Flux Diagram

T	C0	C45	C90	C135	C180	C225	C270	C315
10	2085	1962	1700	1461	1397	1445	1654	1654
20	2080	1892	1449	1069	944.4	1031	1366	1366
30	1866	1658	1132	716.4	584.0	676.9	1036	1036
40	1572	1343	828.3	446.7	318.6	409.1	740.0	740.0
50	1152	1001	540.1	222.7	107.6	194.1	468.4	468.4
60	593.4	562.8	253.7	36.59	12.99	29.40	196.6	196.6
70	169.5	186.5	59.76	4.875	5.799	4.675	36.88	36.88
80	4.680	16.81	1.576	1.973	2.586	1.774	1.364	1.364
90	0.0996	0.0631	0.0831	0.1709	0.1311	0.1950	0.0767	0.0767

DEG LUMINOUS INTENSITY:cd

### Zonal Lumen Summary

T	φ zone	φ total	lum, lamp
0-10	166.4	166.4	5.64, 5.64
10-20	443.9	610.3	20.7, 20.7
20-30	596.3	1207	40.9, 40.9
30-40	623.2	1830	62, 62
40-50	552.8	2383	80.8, 80.8
50-60	367.5	2750	93.3, 93.3
60-70	156.5	2907	98.6, 98.6
70-80	33.63	2940	99.7, 99.7
80-90	1.021	2941	99.7, 99.7

UNIT: lm

### Coefficients Of Utilization

ppc	80%			70%			50%			30%			10%			0
pw	50%	30%	10%	50%	30%	10%	50%	30%	10%	50%	30%	10%	50%	30%	10%	0
pfc	20%			20%			20%			20%			20%			0
RCR	RCR:Room Cavlty Ratio						(CU)									
0.0	119	119	119	116	116	116	111	111	111	106	106	106	102	102	102	0
1.0	108	105	102	106	103	100	101	99	97	98	96	94	94	93	91	89
2.0	97	92	87	95	90	86	92	88	84	89	85	82	86	83	80	79
3.0	87	81	76	86	80	75	83	78	74	80	76	72	78	74	71	69
4.0	79	72	66	78	71	66	75	70	65	73	68	64	71	67	63	61
5.0	72	64	59	71	64	58	69	63	58	67	61	57	65	60	57	55
6.0	66	58	52	65	57	52	63	57	52	61	56	51	60	55	51	49
7.0	60	53	47	59	52	47	58	51	47	57	51	46	55	50	46	44
8.0	56	48	43	55	48	43	54	47	42	52	46	42	51	46	42	40
9.0	51	44	39	51	44	39	50	43	39	49	43	39	48	42	38	37
10.0	48	41	36	47	40	36	46	40	36	45	40	35	45	39	35	34

## Photometric for 6" 40w square trim

Fixture photometry has been conducted accredited testing laboratory in accordance with IESNA LM-79-08. IESNA LM-79-08 specifies the entire luminaire as the source resulting in a fixture efficiency of 100%. Result may vary per actual order.

### Distribution Diagram

CP6-D40W-40T-Square

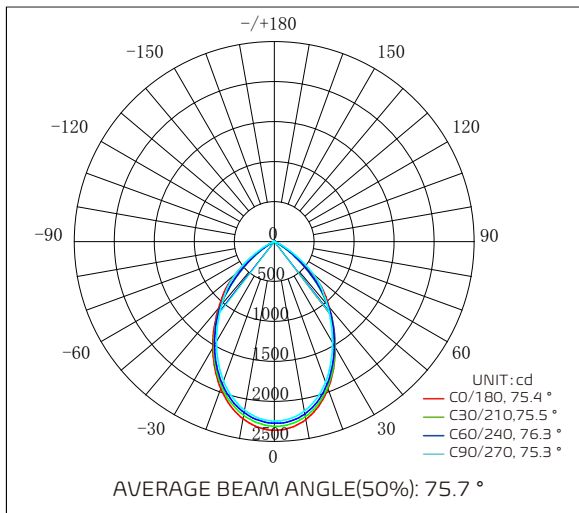

### Average Illuminance Curve

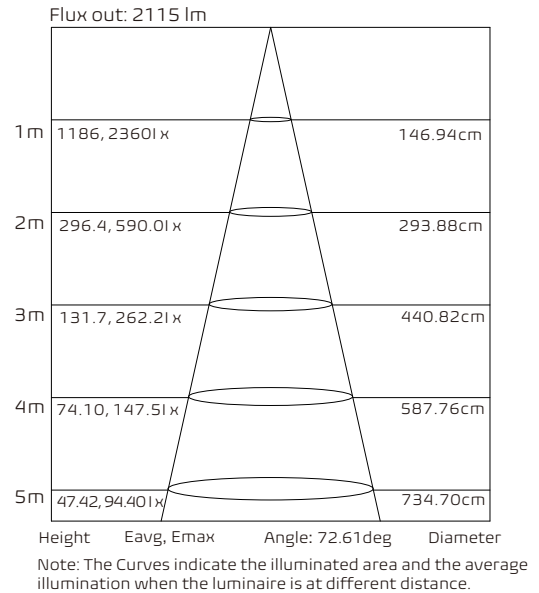

### Zonal Flux Diagram

T	C0	C45	C90	C135	C180	C225	C270	C315
10	2261	2210	2153	2112	2251	2186	2141	2108
20	1961	1938	1872	1833	1958	1913	1857	1821
30	1527	1523	1458	1440	1541	1505	1450	1422
40	1069	1040	1029	989.3	1088	1020	1024	967.2
50	610.2	476.4	642.7	451.9	634.2	457.1	637.9	439.4
60	138.1	98.62	196.9	95.56	147.8	95.34	198.5	90.87
70	10.20	7.550	11.30	5.999	9.294	6.717	12.18	6.998
80	5.189	4.341	5.442	3.213	4.520	4.015	5.773	3.727
90	0.2393	0.3240	0.4220	0.4175	0.5400	0.1953	1.041	0.1559

DEG LUMINOUS INTENSITY:cd

### Zonal Lumen Summary

T	φ zone	φ total	lum, lamp
0-10	211.2	211.2	6.43, 6.43
10-20	572.9	784.1	23.9, 23.9
20-30	773.9	1558	47.4, 47.4
30-40	781.9	2340	71.2, 71.2
40-50	603.2	2943	89.6, 89.6
50-60	275.6	3219	98.98
60-70	46.10	3265	99.4, 99.4
70-80	6.612	3271	99.6, 99.6
80-90	4.014	3275	99.7, 99.7

UNIT: lm

### Coefficients Of Utilization

ppc	80%			70%			50%			30%			10%			0		
pw	50%	30%	10%	50%	30%	10%	50%	30%	10%	50%	30%	10%	50%	30%	10%	0		
pfc	20%			20%			20%			20%			20%			0		
RCR	RCR:Room Cavlty Ratio						(CU)											
0.0	119	119	119	116	116	116	111	111	111	106	106	106	102	102	102	0		
1.0	109	106	103	107	104	102	103	100	98	99	97	95	94	93	91			
2.0	99	94	90	97	93	89	94	90	87	91	88	85	88	86	83	82		
3.0	91	84	80	89	83	79	86	82	78	84	80	76	81	78	75	73		
4.0	83	76	71	81	75	70	79	74	70	77	72	69	75	71	68	66		
5.0	76	69	64	75	68	63	73	67	63	71	66	62	69	65	61	60		
6.0	70	62	57	69	62	57	67	61	57	66	60	56	64	59	56	54		
7.0	64	57	52	64	57	52	62	56	52	61	55	51	60	55	51	49		
8.0	60	52	48	59	52	47	58	52	47	57	51	47	55	50	47	45		
9.0	55	48	44	55	48	44	54	48	43	53	47	43	52	47	43	41		
10.0	52	45	40	51	45	40	50	44	40	49	44	40	48	43	40	38		

## Photometric for 6" 20w square wall wash

Fixture photometry has been conducted accredited testing laboratory in accordance with IESNA LM-79-08. IESNA LM-79-08 specifies the entire luminaire as the source resulting in a fixture efficiency of 100%. Result may vary per actual order.

### Distribution Diagram

CP6-D20W-40W-Square Wall Wash

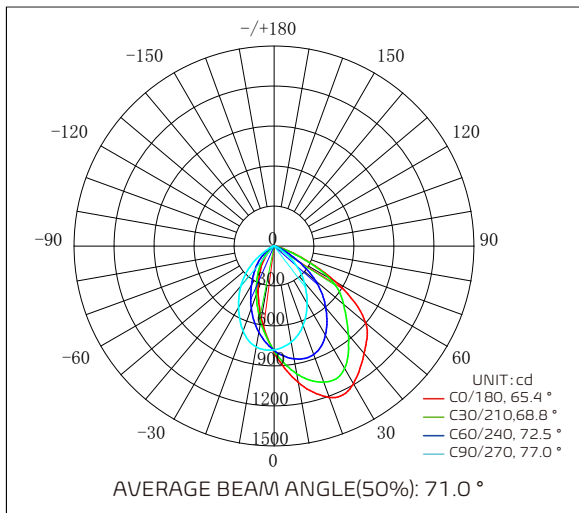

### Average Illuminance Curve

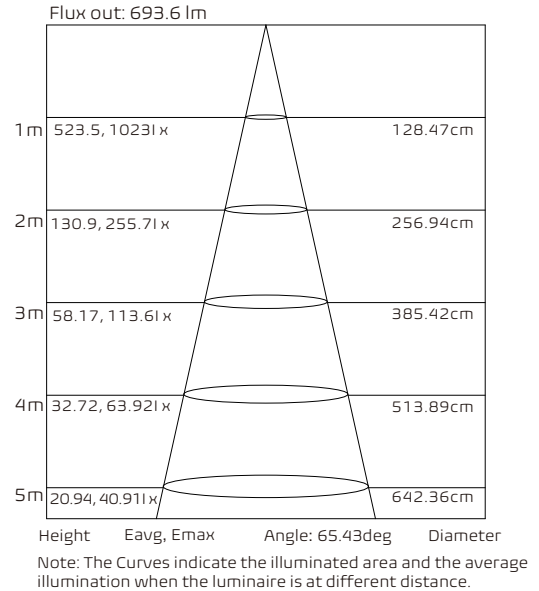

### Zonal Flux Diagram

T	C0	C45	C90	C135	C180	C225	C270	C315
10	1038	919.6	732.9	585.3	554.5	616.2	769.8	942.8
20	1209	984.8	638.0	411.7	535.7	439.8	680.2	1037
30	1192	930.7	494.7	267.4	210.7	287.2	535.8	993.1
40	1053	743.2	354.7	155.9	97.27	170.7	388.6	789.6
50	896.8	548.9	205.7	66.71	21.28	79.17	231.3	587.6
60	526.2	310.4	73.90	12.46	5.292	14.93	82.68	371.6
70	136.0	73.16	14.65	4.282	4.094	4.888	15.92	99.23
80	12.17	4.784	1.600	3.400	3.395	3.294	2.004	8.560
90	0.1674	0.0925	0.0768	0.1779	0.0947	0.0635	0.1183	0.1624

DEG LUMINOUS INTENSITY:cd

### Zonal Lumen Summary

T	φ zone	φ total	%lum, lamp
0-10	73.89	73.89	4.65, 4.65
10-20	210.5	284.3	17.9, 17.9
20-30	307.9	592.3	37.2, 37.2
30-40	336.9	929.2	58.4, 58.4
40-50	305.6	1235	77.6, 77.6
50-60	226.0	1461	91.8, 91.8
60-70	102.0	1563	98.3, 98.3
70-80	21.16	1584	99.6, 99.6
80-90	2.195	1586	99.7, 99.7

UNIT: lm

### Coefficients Of Utilization

ppc	80%			70%			50%			30%			10%			0
pw	50%	30%	10%	50%	30%	10%	50%	30%	10%	50%	30%	10%	50%	30%	10%	0
pfc	20%			20%			20%			20%			20%			0
RCR	RCR:Room Cavlty Ratlo						(CU)									
0.0	119	119	119	116	116	116	111	111	111	106	106	106	102	102	102	0
1.0	107	104	101	105	102	99	101	98	96	97	95	93	93	92	90	88
2.0	96	90	86	94	89	85	91	86	83	88	84	81	85	82	79	77
3.0	86	79	74	85	78	73	82	76	72	79	74	71	77	73	69	67
4.0	77	70	64	76	69	64	74	68	63	72	66	62	69	65	61	59
5.0	70	62	56	69	62	56	67	60	55	65	59	55	63	58	54	52
6.0	64	56	50	63	55	50	61	54	49	59	53	49	58	53	48	47
7.0	58	50	45	57	50	45	56	49	44	55	48	44	53	48	44	49
8.0	53	46	40	53	45	40	51	45	40	50	44	40	49	44	39	38
9.0	49	42	37	49	41	36	48	41	36	47	40	36	46	40	36	34
10.0	46	38	33	45	38	33	44	38	33	43	37	33	42	37	33	31